

フレーム1側 / Frame1 side

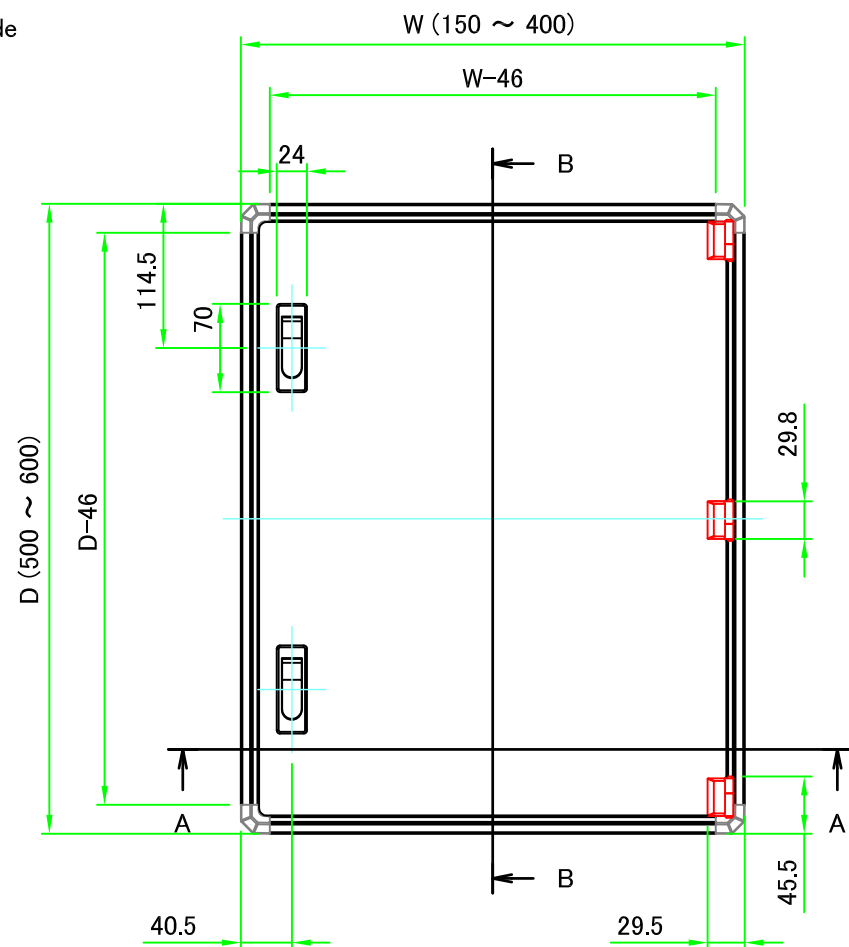

フレーム3側 / Frame3 side

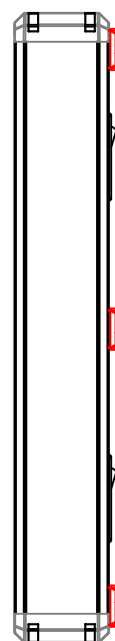

フレーム4側 / Frame4 side

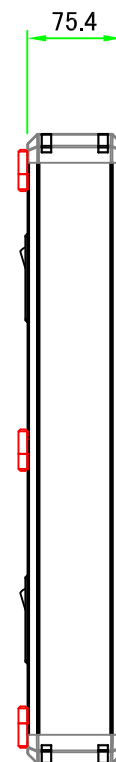

B-B (1:6)

有効寸法 / MAX dim. 69

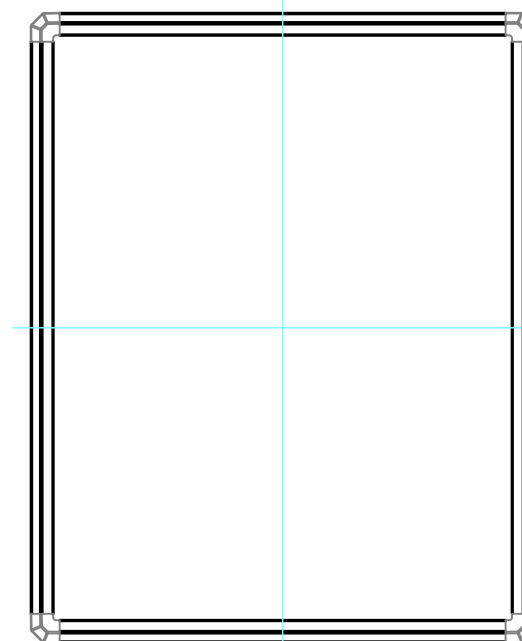
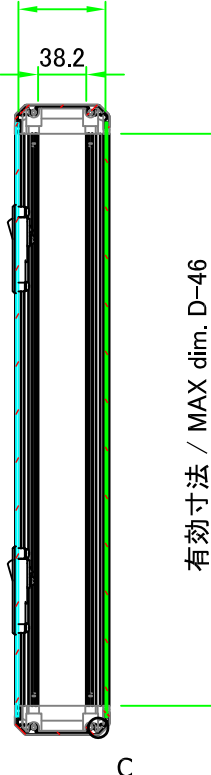

フレーム2側 / Frame2 side

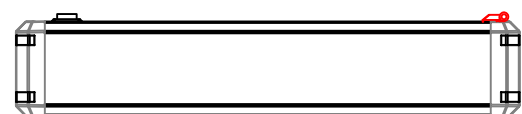

A-A (1:6)

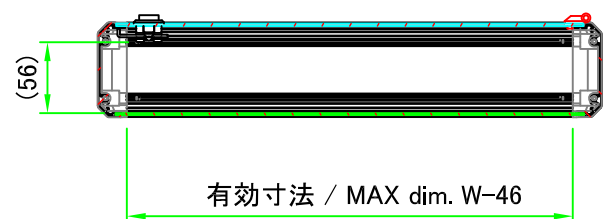

C: フレーム拡大図 / Frame cross-section

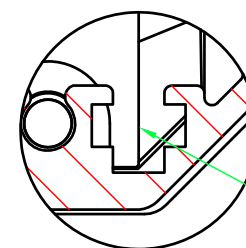

ナットレール / Nut rail

スライドナット用溝
別売オプション品 スライドナット FZ-3 を入れる事が出来ます。
Groove for slide nut
Slide nut FZ-3 (sold separately as optional parts) can be inserted.

株式会社タカチ電機工業 TAKACHI ELECTRONICS ENCLOSURE CO., LTD.			品名/Title 開閉式フリーサイズボックス CUSTOM DIMENSIONS BOX	尺度/Scale 1:6
承認/Approved	検図/Checked	製図/Created	型番/Product number FCWS□-□-75□□ (D500~600)	
中根	野村	中根	作成日/Date 2019/04/18	2 / 5

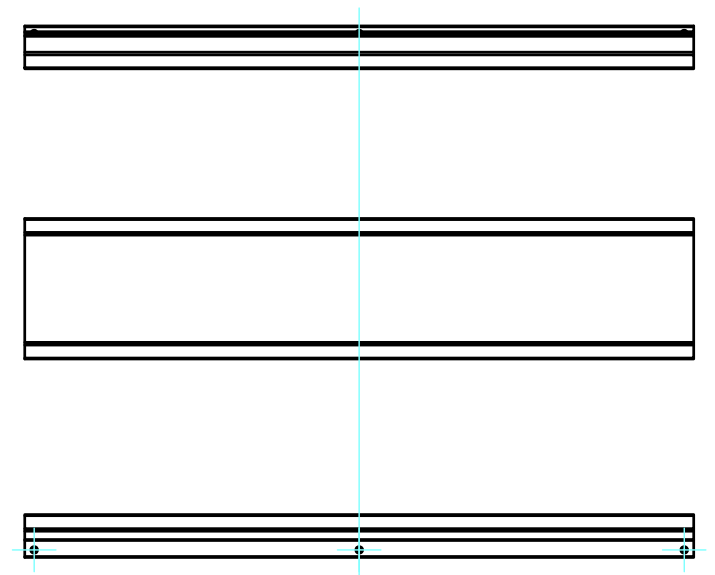
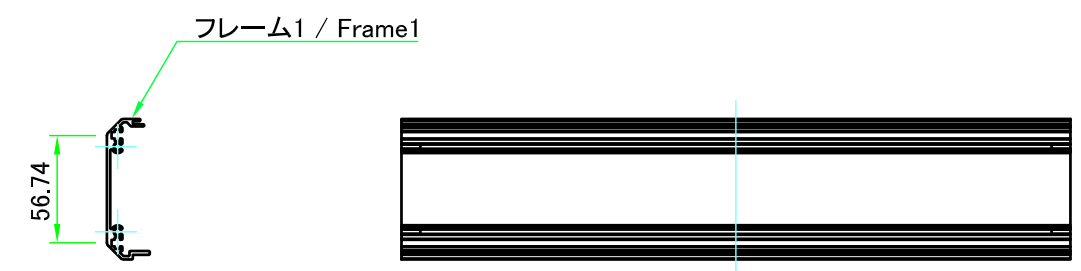
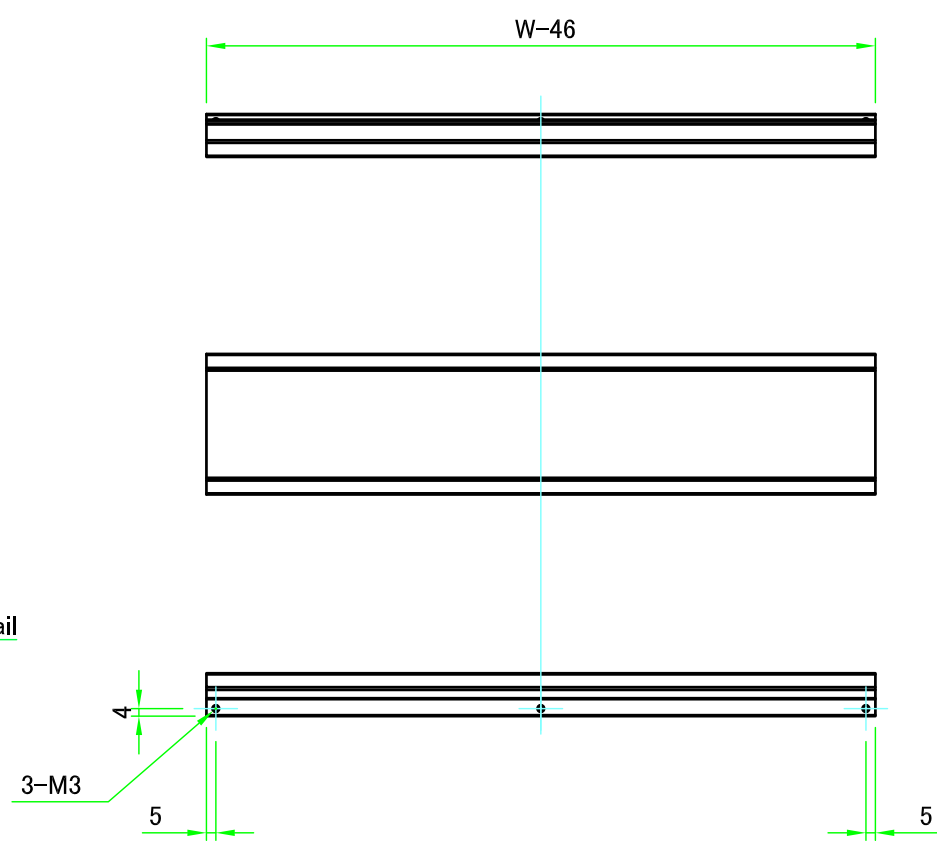
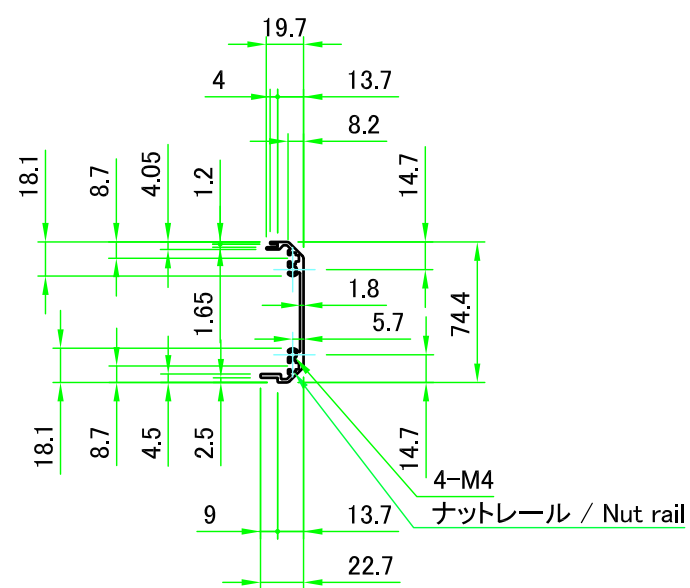

株式会社タカチ電機工業 TAKACHI ELECTRONICS ENCLOSURE CO., LTD.			品名/Title フレーム1, 2 Frame1, 2	尺度/Scale 1:4
承認/Approved	検図/Checked	製図/Created	型番/Product number H75.4 - W150 ~ 400	
中根	野村	中根	作成日/Date 2019/04/18	3 / 5

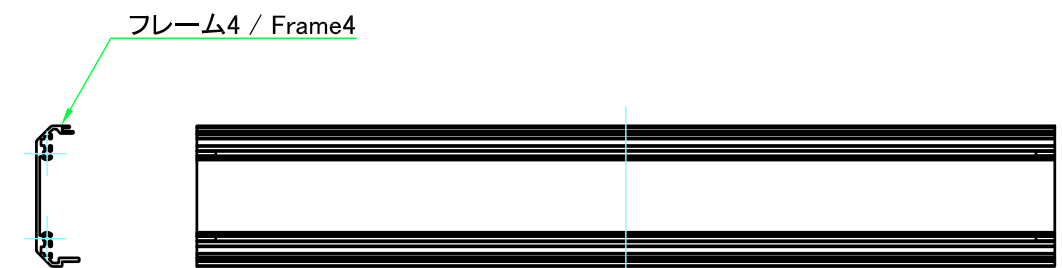
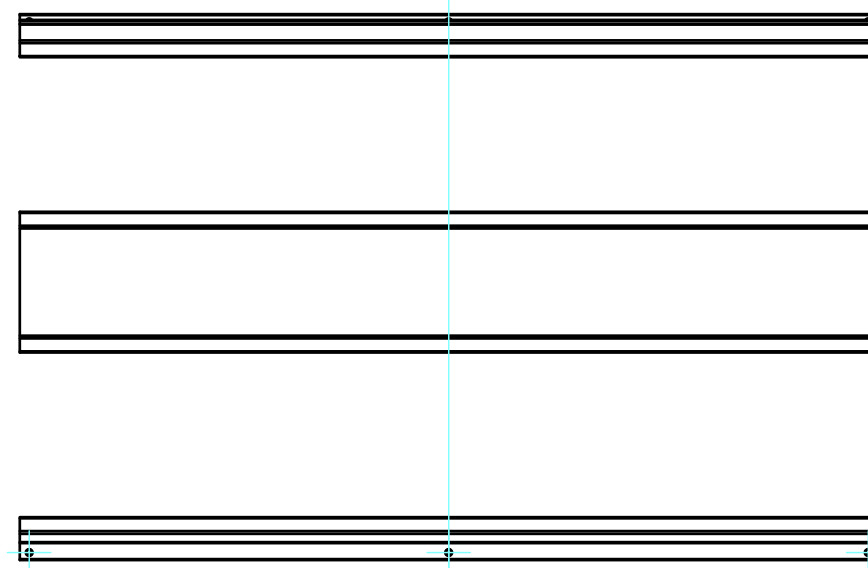
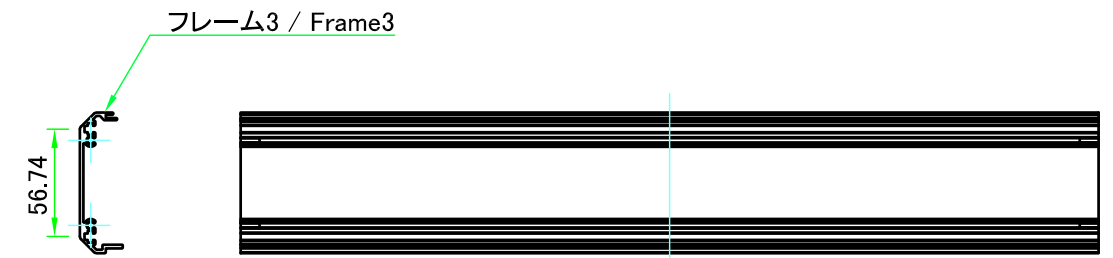
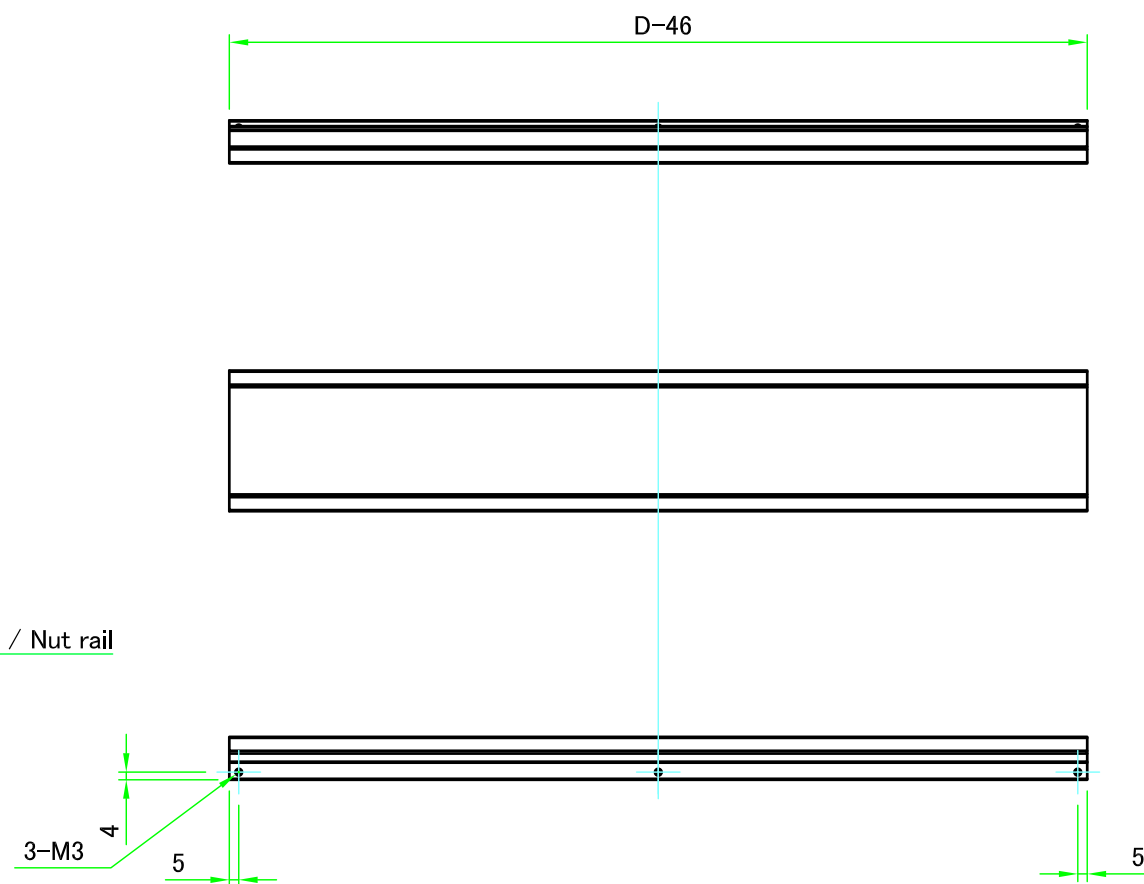
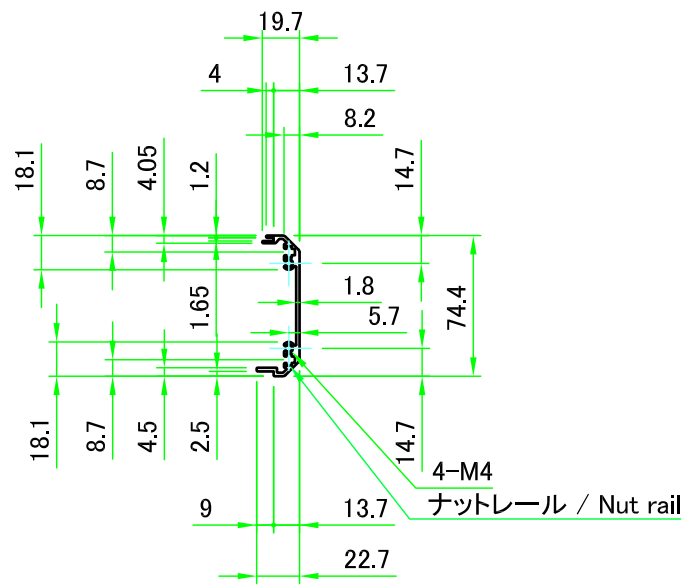

株式会社タカチ電機工業 TAKACHI ELECTRONICS ENCLOSURE CO., LTD.			品名/Title フレーム3, 4 Frame3, 4	尺度/Scale 1:4
承認/Approved 中根	検図/Checked 野村	製図/Created 中根	型番/Product number H75.4 - D500~600	
			作成日/Date 2019/04/18	4 / 5

開閉パネル / Open-closing panel

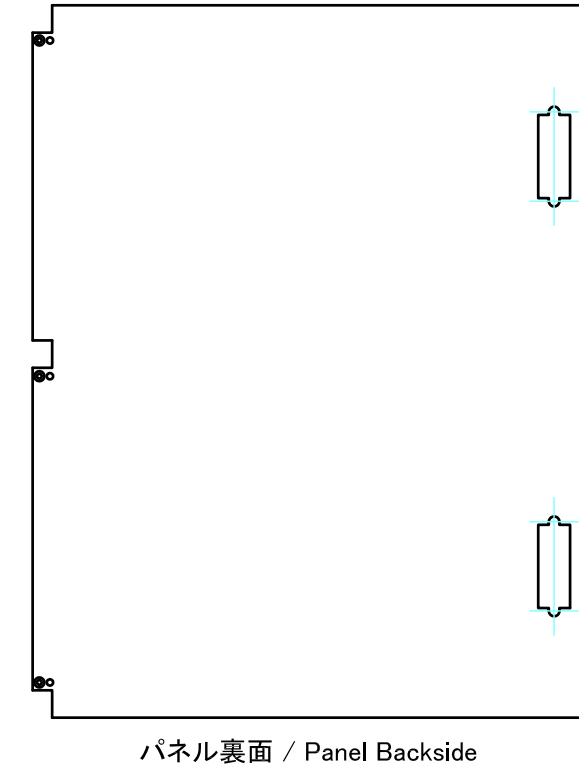
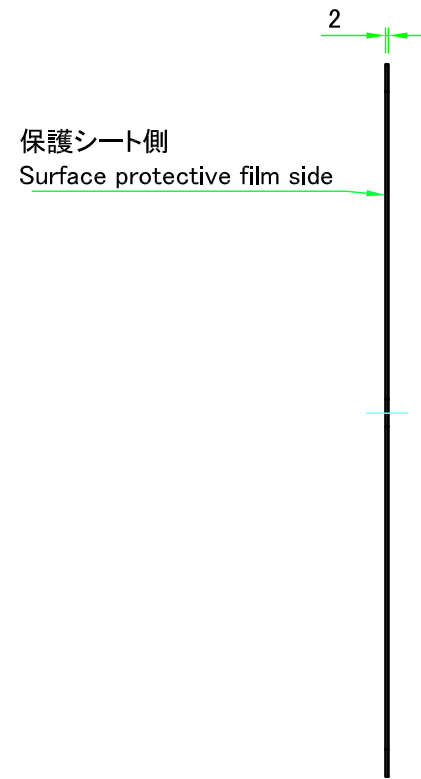
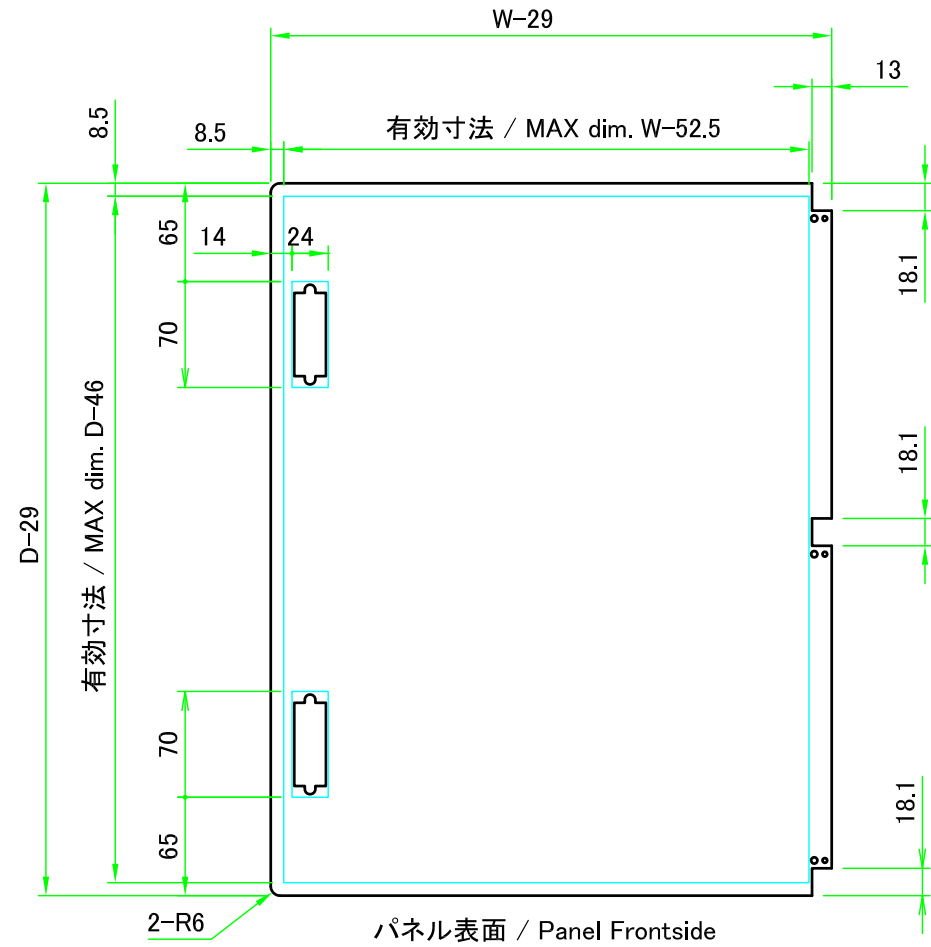

ハメ込みパネル / Slide panel

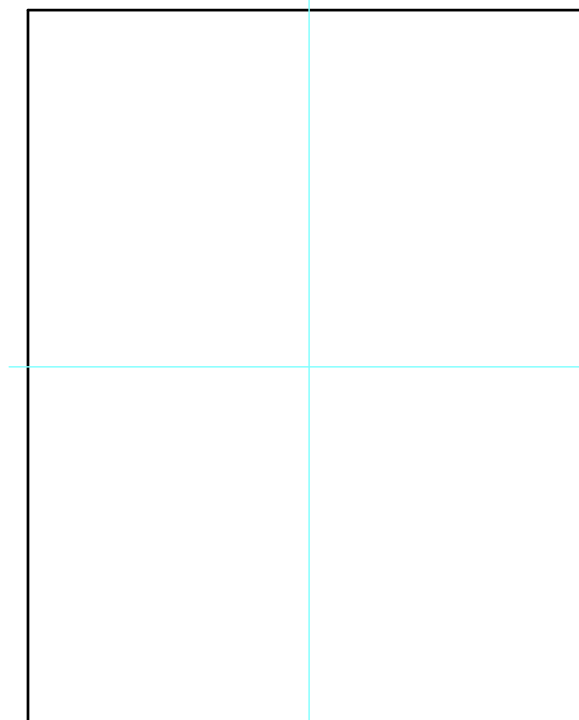
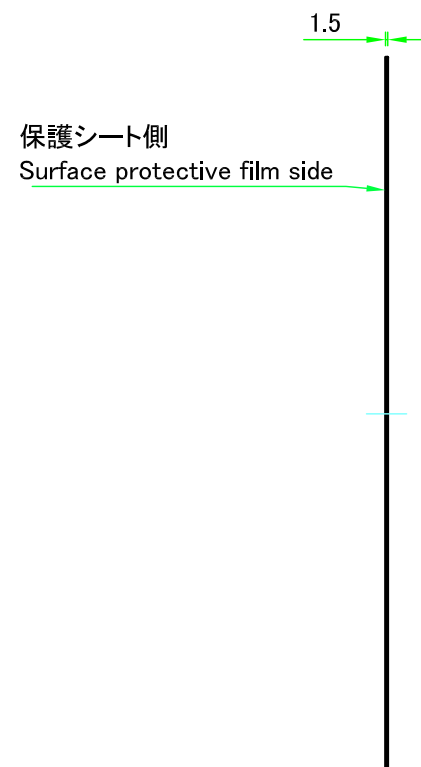
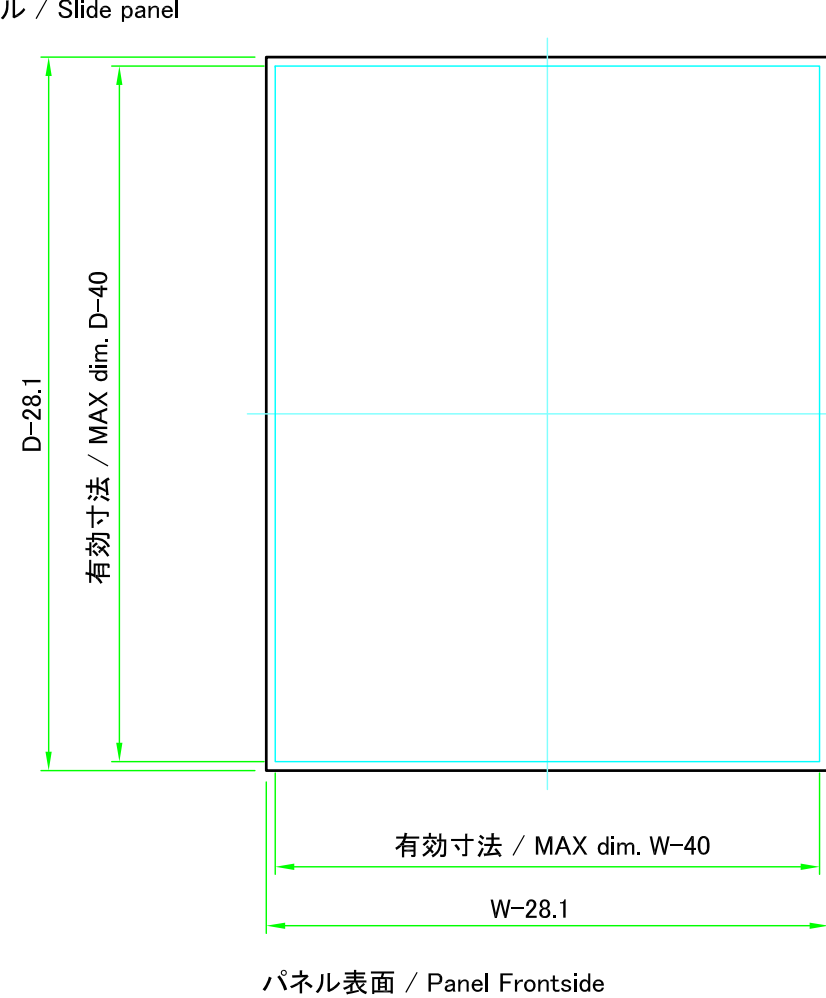

株式会社タカチ電機工業 TAKACHI ELECTRONICS ENCLOSURE CO., LTD.			品名/Title パネル Panel	尺度/Scale 1:5
承認/Approved	検図/Checked	製図/Created	型番/Product number W150~400 - D500~600	
中根	野村	中根	作成日/Date 2019/04/18	5 / 5